

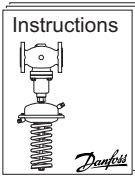









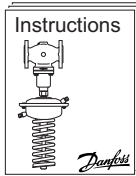

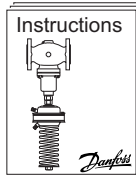
Instructions

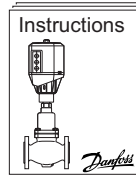
VFG 2, VFG 21, VFG 27, VFG 25, VFGS 2 DN 15 - 125

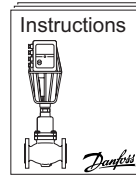

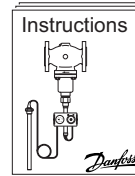
  AFD / VFG.. AFP / VFG..	  AFA / VFG.. AFPA / VFG..	  SAF / VFG	  AMV(E) 4.. / VFG..	  AMV(E) 6.. / VFG..	  AFT.. / VFG.. STFW / VFG	  STFL / VFG..
 AFD / AFP	 AFA / AFPA	 SAF	 AMV (E) 4..	 AMV (E) 6..	 AFT... STFW	 STFL

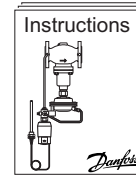
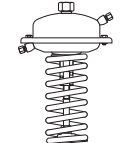
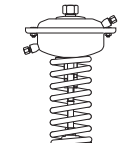
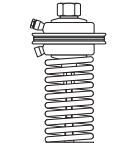
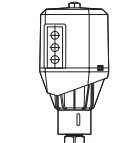
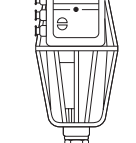
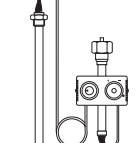
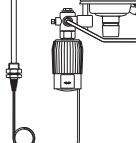
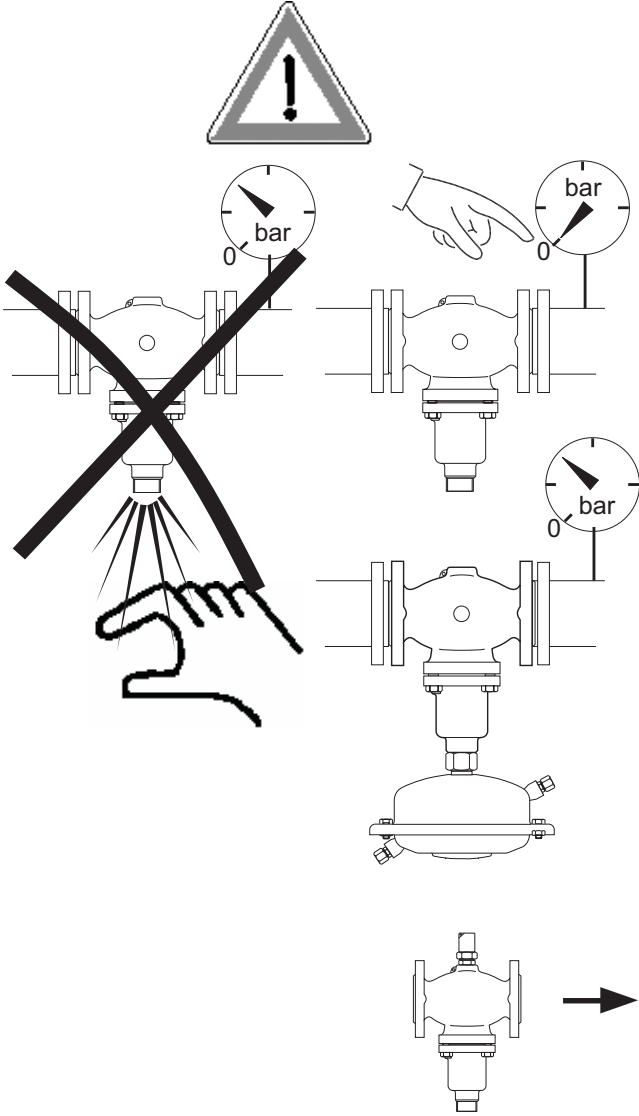
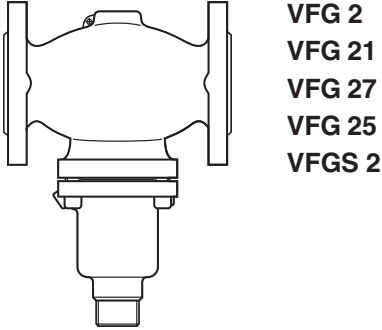

Instructions

VFQ 2, VFQ 21 DN 15 - 125



AFQ / VFQ..

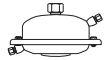

AFQ



AFPB (-F) / VFQ..

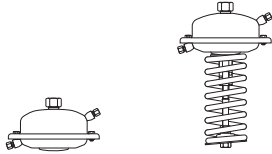

AFPB-F

AFP

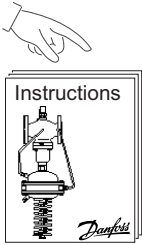

AFPQ (4) / VFQ..

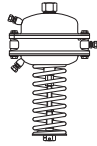

AFPQ,
AFPQ.4

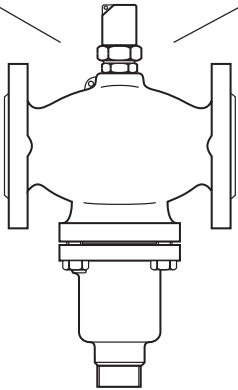

VFQ 2
VFQ 21

